



सत्यमेव जयते

Department of Industrial Policy and Promotion
Ministry of Commerce and Industry
Government of India

IPR ENFORCEMENT TOOLKIT FOR POLICE



This toolkit has been compiled by Saikrishna & Associates and seeks to explain the basic concepts of Trademark and Copyright Infringements in India with a view to aid police officials in combating widespread counterfeiting and piracy.



सत्यमेव जयते

Department of Industrial Policy and Promotion
Ministry of Commerce and Industry
Government of India

IPR ENFORCEMENT TOOLKIT FOR POLICE



रमेश अभिषेक

RAMESH ABHISHEK

सचिव

Secretary



भारत सरकार
औद्योगिक नीति और संवर्धन विभाग
वाणिज्य एवं उद्योग मंत्रालय
उद्योग भवन, नई दिल्ली-110 011
Government of India
Deptt. of Industrial Policy and Promotion
Ministry of Commerce & Industry
Udyog Bhawan, New Delhi-110 011
Tel. : 23061815, 23061667 Fax : 23061598
e-mail : secy-ipp@nic.in

MESSAGE



5th December, 2016

Intellectual Property is a rapidly developing field related to creation, use and exploitation of mental or creative labor. It has today emerged as a highly valued financial asset in organizations and plays an indispensable role in the economic growth of a nation. Like any other asset, Intellectual Property needs to be protected. Intellectual Property Rights (IPRs) enforcement aims at safeguarding the interests of innovators and creators, ensuring that they enjoy the fruits of their labour to which they are rightfully entitled.

However, with the advent of globalization and technology, the number of IP crimes in the brick-and-mortar as well as in the digital context has increased exponentially. The rights of the IP owners are increasingly at risk as infringement by way of counterfeiting or piracy is being carried out with impunity. This IPR Enforcement Toolkit for Police is an initiative to strengthen the enforcement regime of IPRs in the country and thereby take forward the clarion call of "Creative India; Innovative India" enshrined in the National IPR Policy.

I would like to extend my gratitude to the Federation of Indian Chambers of Commerce and Industry (FICCI) and their partners for their painstaking efforts in development of the Toolkit. I take immense pleasure in sharing the IPR Enforcement Toolkit for Police. I believe this Toolkit will be of great help to police officials across the states in curbing the menace of IP Crime.

(Ramesh Abhishek)

Foreword



Intellectual property is an important discipline covering numerous aspects pertaining to creation, innovation and securing rights of the holder of intellectual property. Being a marketable tool as well as a financial asset, Intellectual property plays a crucial role in economic growth of a country and hence has become an international agenda for debate and discussion.

It is now well-established that creativity and innovation is the key to the prosperity of a country. However, an economy can disintegrate if menaces like counterfeiting and piracy are not addressed within a suitable time period. India's National IPR Policy rightly seeks to reinforce the IPR framework in the country. This, among other things, calls for an urgent need to strengthen the country's enforcement mechanisms for combating IPR infringements. The issue being intricate demands stern consideration of the enforcement agencies to build the capacity of their officials at various levels, including strengthening of IPR cells in State police forces, especially to curb the rising levels of counterfeiting and piracy.

FICCI's Intellectual Property Rights Division is intensively involved with the issues pertaining to protection and enforcement of IP Rights, and we are pleased to present the Enforcement Tool Kit for Police Officials. It is hoped that this Tool Kit will serve as a ready reckoner for the Police Officials while dealing with the menace of counterfeiting and piracy which is posing a serious threat to the nation's economy.

I would like to thank the Department of Industrial Policy & Promotion, Government of India, for the valuable guidance and support provided towards the development of the Tool Kit. I express my gratitude to the FICCI IPR Committee Members for their constructive inputs for this important document. I also take this opportunity to acknowledge and appreciate our knowledge partner, Saikrishna & Associates, for their pivotal role in and contribution to the development of this tool kit for Police Officials.

Dr. A. Didar Singh
Secretary General
FICCI

TABLE OF CONTENTS

Chapter 1 ENFORCEMENT TOOL KIT.	1
1. Background and Objective.	1
2. What is the difference between counterfeiting and piracy?	2
3. Trade Mark and Copyright	4
4. Criminal Offences under the Trade Marks Act, 1999	8
5. Criminal Offences under the Copyright Act, 1957	13
6. Classification of Offences under the Code of Criminal Procedure, 1973:	15
7. Criminal offences under the Indian Penal Code, 1860.	15
8. Search and Seizure Powers of Police in IP Crimes	23
Chapter 2 GENERAL GUIDELINES FOR SEARCH AND SEIZURE	29
Chapter 3 CHECKLIST FOR REGISTERING COMPLAINT.	33
Chapter 4 CHECKLIST FOR SEARCH AND SEIZURE	39
ANNEXURES	45
ANNEXURE I SAMPLE FORMS	46
ANNEXURE II CABLE PIRACY OF PAY TV SIGNAL.	61
ANNEXURE III SOURCE TO ONLINE PIRACY	65

Chapter 1

ENFORCEMENT TOOL KIT

1. Background and Objective

The National IPR Policy ("the Policy") published by the Government of India on May 12th 2016 focusses on strengthening enforcement mechanisms for IPR infringement amongst its 7 principal objectives.

India has a TRIPS compliant, robust, equitable and dynamic IPR regime, and the Policy envisions an India where intellectual property protection leads to an increase in creativity and innovation, advancement in science, technology, art and culture, and protection of traditional knowledge and biodiversity resources.

The nature of IP crimes today spans the physical and digital domains. Trade mark and copyright infringement including counterfeiting and piracy are carried out by organisations that operate as a part of sophisticated criminal networks with global links. Technological advancement has created new benefits and opportunities to society at large. As we seek to move into an era where IPR reforms will drive creativity and innovation, there is an immediate need to act against outright counterfeiting and piracy.

The negative impact of rampant counterfeiting / piracy is far reaching on the country and on IP owners and stakeholders who depend on IP assets for their livelihood either directly or indirectly. The impact is economic and social, and results in huge financial losses to the exchequer as well. It is therefore imperative to build a conducive environment for IP owners to enforce their Intellectual Property Rights.

The objective of this tool kit is to provide a standardised ready reckoner for law enforcement agencies in India in relation to enforcement efforts against IP crimes, specifically trade mark and copyright counterfeiting and piracy. This enforcement toolkit contains

- a. Details on offences under IP laws such as Trade Marks Act, 1999, Copyright Act, 1957 and applicable provisions of the Indian Penal Code, 1860;
- b. Powers available to police for search and seizure under the IP laws and Criminal Procedure Code, 1973;
- c. Checklists for registering a complaint, and for search and seizure operations in relation to IP Crimes.

2. What is the difference between counterfeiting and piracy?

Counterfeit	Piracy
<p>A counterfeit good is an unauthorised imitation of a branded good. Exact imitation is not essential to counterfeiting and the imitation should have a deceptive quality to it.</p> <p>According to the TRIPS Agreement, <i>"Counterfeit trademark goods shall mean any goods, including packaging, bearing without authorisation a trademark which is identical to the trademark validly registered in respect of such goods, or which cannot be distinguished in its essential aspects from such a trademark and which thereby infringes the rights of the owner of the trademark in question under the law of the country of importation."</i></p> <p>As per Section 28 of the Indian Penal Code, <i>"a person is said to "counterfeit" who causes one thing to resemble another thing, intending by means of that resemblance to practise deception,</i></p>	<p>Piracy involves an unauthorised exact copy -not a simple imitation - of an item covered by an intellectual property right.¹</p> <p>According to the TRIPS Agreement, <i>"Pirated copyright goods shall mean any goods which are copies made without the consent of the right holder or person duly authorised by the right holder in the country of production and which are made directly or indirectly from an article where the making of that copy would have constituted an infringement of a copyright or a related right under the law of the country of importation."</i></p> <p>Indian law deals with piracy through provisions relating to copyright infringement. As per Section 51 of the Copyright Act, 1957, a copyright in a work is deemed to be infringed when any person, without a licence granted by the owner of the Copyright or the Registrar of Copyrights does anything which is the exclusive right of the</p>

¹ http://europa.eu/rapid/press-release_MEMO-10-272_en.htm

Counterfeit	Piracy
<p><i>or knowing it to be likely that deception will thereby be practised."</i></p>	<p>copyright owner, permits for profit any place to be used for the performance of the work in public where such performance constitutes an infringement of the copyright in the work, or makes for sale or hires or sells or lets for hire or distributes either for the purpose of trade or to such an extent as to affect prejudicially the owner of the copyright or imports into India, any infringing copies of the work.</p> <p>In addition to physical piracy by reproducing a protected work without authorisation, piracy can also occur online. Online piracy is a term specifically used to refer to illegal copying of a protected work from the Internet.</p> <p>In the case of television broadcasting, piracy means and include unauthorized transmission / retransmission of signals of television channels by any person and includes transmission / retransmission by authorized operator(s) in an unauthorized mode or beyond the authorized territory / area. Piracy of television channels may amount to infringement of the following rights: copyright / broadcast reproduction right, theft*, cheating and criminal breach of trust**.</p> <p>*Signals are moveable property. - <i>Abdulgafar A. Nadiadwala vs Assistant Commissioner of Income-Tax</i> (2004) 188 CTR Bom. 232</p> <p>** When signals are retransmitted in unauthorized areas or in an unauthorized mode in violation of the terms of entrustment of signals by an authorized operator.</p>

3. Trade Mark and Copyright

A. Trade Marks

A trade mark² is a source identifier denoting that a product belongs to a certain company or person, and distinguishes it from the products of others. A trade mark may be a sign, design or expression.

A logo protected by trade mark laws may also be protected under copyright law as an artistic work.

B. Different types of Trade Marks

A trade mark may be registered for goods (by manufacture) or for services (by service provider), and may be categorised as follows:

- a. Standard Trademark: (applied for by proprietors of the trademark);
- b. Certification Trademark: (applied for by the certifying authority);
- c. Collective trademark: (applied for by a group where all the members may use the TM).

² **Section 2 (zb) – Trade Marks Act, 1999-** "trade mark" means a mark capable of being represented graphically and which is capable of distinguishing the goods or services of one person from those of others and may include shape of goods, their packaging and combination of colours; and--

(i) in relation to Chapter XII (other than section 107), a registered trade mark or a mark used in relation to goods or services for the purpose of indicating or so as to indicate a connection in the course of trade between the goods or services, as the case may be, and some person having the right as proprietor to use the mark; and

(ii) in relation to other provisions of this Act, a mark used or proposed to be used in relation to goods or services for the purpose of indicating or so to indicate a connection in the course of trade between the goods or services, as the case may be, and some person having the right, either as proprietor or by way of permitted user, to use the mark whether with or without any indication of the identity of that person, and includes a certification trade mark or collective mark;

Trade marks are also classified as conventional trade marks and non-conventional trade marks. Conventional trade marks include:

- word marks
- stylised marks
- logos
- Labels
- Product Packaging / Trade Dress
- Slogans/catch lines

Recognized non-conventional trade marks:

- Sound marks
- Colour marks

In addition, protection has also been sought for dynamic mark, moving mark and smell mark in the past.

C. Copyright

The 6 different types of "works" are recognised under the Copyright Act, 1957:

1. **Literary Works** (including computer programs / software) - for instance: books, articles, databases, poems, lyrics etc.
2. **Artistic Works** - for instance: labels, paintings, drawings, sketches, maps etc.
3. **Dramatic Work** - for instance: any piece of recitation, choreographic work, scenic arrangement which is fixed in writing etc.
4. **Musical Work** - for instance: musical composition which may be void of graphical notation etc.

5. Sound Recordings - for instance: recording of a musical composition in a CD or any other suitable medium etc.

6. Cinematograph Films - for instance: essentially a visual recording and includes a sound recording etc.

D. Exclusive Rights (copyright) in different works under the Copyright Act, 1957:

The Copyright Act, 1957 grants a bundle of exclusive rights, in works, in favour of the copyright owner. These exclusive rights according to the relevant works are *inter alia* identified below:

Exclusive Right	Works
Reproduction and Storage including in electronic form	<ul style="list-style-type: none"> - Literary Works; - Musical Works - Artistic Works - Dramatic Works - Computer programs - Cinematograph film - Sound recording
Issue copies (distribution)	<ul style="list-style-type: none"> - Literary Works; - Musical Works - Artistic works - Dramatic Works - Computer programs
Performing in public	<ul style="list-style-type: none"> - Literary Works; - Musical Works - Dramatic Works
Communication to the public	<ul style="list-style-type: none"> - Literary works; - Musical Works - Artistic works - Dramatic works - Computer programs - Sound recordings - Cinematograph Films

Exclusive Right	Works
Translation	<ul style="list-style-type: none"> - Literary Works - Musical Works - Dramatic Works - Computer programme
Adaptation	<ul style="list-style-type: none"> - Literary Works - Musical Works - Dramatic Works - Artistic Works - Computer programme
Sell / Rental	<ul style="list-style-type: none"> - Computer programs - Sound recordings - Cinematograph Films

In addition to copyright, the Copyright Act, 1957 also confers some specific rights, ***akin to copyright***, namely:

1. Broadcast Reproduction Right (Section 37)
2. Performer's Rights (Section 38) And (Section 38a)

E. Exclusive Rights in Broadcasts and Performances under the Copyright Act, 1957:

Right akin to Copyright granted by the Copyright Act, 1957	Exclusive Right
Broadcast Reproduction Right	<ul style="list-style-type: none"> - To re-broadcast the Broadcast - To cause the broadcast to be heard or seen by the public on payment of any charges - To make any sound recording or visual recording of the broadcast - To make any reproduction of such sound recording or visual recording where such initial recording was done without licence or, where it was licensed, for any purpose not envisaged by such licence

Right akin to Copyright granted by the Copyright Act, 1957	Exclusive Right
	<ul style="list-style-type: none"> - To sell or give on commercial rental, or offer for such sale or such rental, any such sound recording or visual recording referred to above.
Performers Rights	<ul style="list-style-type: none"> - To make a sound recording or a visual recording of the performance - Right to Reproduce and store the said recording of the performance - Right to issue copies of the said recording to the public - Right to communicate the said recording of the performance to the public - Selling or giving on commercial rental, or offering for such sale or such rental, any copy of the said recording - Right to Broadcast or communicate the performance to the public except where performance is already broadcast.

4. Criminal Offences under the Trade Marks Act, 1999

S. No.	Provision under the Trade Marks Act	Definition of/ Punishment for the Criminal Offence
1.	<p>Section 101 Meaning of applying trademarks and trade descriptions</p>	<p>(1) A person shall be deemed to apply a trade mark or mark or trade description to goods or services who--</p> <ul style="list-style-type: none"> (a) applies it to the goods themselves or uses it in relation to services; or (b) applies it to any package in or with which the goods are sold, or exposed for sale, or had in possession for sale or for any purpose of trade or manufacture, or (c) places, encloses or annexes any goods which are sold, or exposed

S. No.	Provision under the Trade Marks Act	Definition of/ Punishment for the Criminal Offence
		<p>for sale, or had in possession for sale or for any purpose of trade or manufacture, in or with any package or other thing to which a trade mark or mark or trade description has been applied; or</p> <p>(d) uses a trade mark or mark or trade description in any manner reasonably likely to lead to the belief that the goods or services in connection with which it is used are designated or described by that trade mark or mark or trade description; or</p> <p>(e) in relation to the goods or services uses a trade mark or trade description in any sign, advertisement, invoice, catalogue, business letter, business paper, price list or other commercial document and goods are delivered or services are rendered to a person in pursuance of a request or order made by reference to the trade mark or trade description as so used.</p>
2.	<p>Section 102 Meaning of falsifying and falsely applying trade marks</p>	<p>(1) A person shall be deemed to falsify a trade mark who, either,--</p> <p>(a) without the assent of the proprietor of the trade mark makes that trade mark or a deceptively similar mark; or</p> <p>(b) falsifies any genuine trade mark, whether by alteration, addition, effacement or otherwise.</p> <p>(2) A person shall be deemed to falsely apply to goods or services a trade mark who, without the assent of the proprietor of the trade mark,--</p> <p>(a) applies such trade mark or a deceptively similar mark to goods or services or any package containing goods</p>

S. No.	Provision under the Trade Marks Act	Definition of/ Punishment for the Criminal Offence
		<p>(b) uses any package bearing a mark which is identical with or deceptively similar to the trade mark of such proprietor, for the purpose of packing, filling or wrapping therein any goods other than the genuine goods of the proprietor of the trade mark.</p> <p>(3) Any trade mark falsified as mentioned in sub-section (1) or falsely applied as mentioned in sub-section (2), is in this Act referred to as a false trade mark.</p> <p>(4) In any prosecution for falsifying a trade mark or falsely applying a trade mark to goods or services, the burden of proving the assent of the proprietor shall lie on the accused.</p>
3.	<p>Section 103 Penalty for applying false trademarks, trade descriptions, etc.</p>	<p>Any person who-</p> <p>(a) falsifies any trade mark; or</p> <p>(b) falsely applies to goods or services any trade mark; or</p> <p>(c) makes, disposes of, or has in his possession, any die, block, machine, plate or other instrument for the purpose of falsifying or of being used for falsifying, a trade mark; or</p> <p>(d) applies any false trade description to goods or services; or</p> <p>(e) applies to any goods to which an indication of the country or place in which they were made or produced or the name and address of the manufacturer or person for whom the goods are manufactured is required to be applied under section 139, a false indication of such country, place, name or address; or</p> <p>(f) tampers with, alters or effaces an indication of origin which has been applied to any goods to which it is required to be applied under section 139; or</p>

S. No.	Provision under the Trade Marks Act	Definition of/ Punishment for the Criminal Offence
		<p>(g) causes any of the things above-mentioned in this section to be done, shall be punishable with:</p> <p>Imprisonment for a term which shall not be less than six months but which may extend to three years and with fine which shall not be less than fifty thousand rupees but which may extend to two lakh rupees:</p> <p>Provided that the court may, for adequate and special reasons to be mentioned in the judgment, impose a sentence of imprisonment for a term of less than six months or a fine of less than fifty thousand rupees.</p>
4.	<p>Section 104</p> <p>Penalty for selling goods or providing services to which false trade mark or false trade description is applied</p>	<p>Any person who sells, lets for hire or exposes for sale, or hires or has in his possession for sale, goods or things, or provides or hires services, to which any false trade mark or false trade description is applied or which, being required under section 139 to have applied to them an indication of the country or place in which they were made or produced or the name and address of the manufacturer, or person for whom the goods are manufactured or services provided, as the case may be, are without the indications so required, shall, unless he proves,--</p> <p>(a) that, having taken all reasonable precautions against committing an offence against this section, he had at the time of commission of the alleged offence no reason to suspect the genuineness of the trade mark or trade description or that any offence had been committed in respect of the goods or services; or</p> <p>(b) that, on demand by or on behalf of the prosecutor, he gave all the information in his power with respect to the person from whom he obtained such goods or things or services; or</p>

S. No.	Provision under the Trade Marks Act	Definition of/ Punishment for the Criminal Offence
		<p>(c) that otherwise he had acted innocently, shall be punishable with Imprisonment for a term which shall not be less than one year but which may extend to three years and with fine which shall not be less than one lakh rupees but which may extend to two lakh rupees.</p>
5.	<p>Section 105 Enhanced Penalty on second or subsequent conviction</p>	<p>Imprisonment for a term which shall not be less than one year but which may extend to three years and with fine which shall not be less than one lakh rupees but which may extend to two lakh rupees</p> <p>Provided that the court may, for adequate and special reasons to be mentioned in the judgment, impose a sentence of imprisonment for a term of less than one year or a fine of less than one lakh rupees:</p> <p>Provided further that for the purposes of this section, no cognizance shall be taken of any conviction made before the commencement of this Act.</p>
6.	<p>Section 114 Offences by Companies</p>	<p>1) If the person committing an offence under this Act is a company, the company as well as every person in charge of, and responsible to, the company for the conduct of its business at the time of the commission of the offence shall be deemed to be guilty of the offence and shall be liable to be proceeded against and punished accordingly:</p> <p>Provided that nothing contained in this sub-section shall render any such person liable to any punishment if he proves that the offence was committed without his knowledge or that he exercised all due diligence to prevent the commission of such offence.</p> <p>(2) Notwithstanding anything contained in sub-section (1), where an offence under this Act has been committed by a company and it is proved that the</p>

S. No.	Provision under the Trade Marks Act	Definition of/ Punishment for the Criminal Offence
		<p>offence has been committed with the consent or connivance of, or that the commission of the offence is attributable to any neglect on the part of, any director, manager, secretary or other officer of the company, such director, manager, secretary or other officer shall also be deemed to be guilty of that offence and shall be liable to be proceeded against and punished accordingly.</p> <p>Explanation.--For the purposes of this section--</p> <p>(a) "company" means any body corporate and includes a firm or other association of individuals; and</p> <p>(b) "director", in relation to a firm, means a partner in the firm.</p>

5. Criminal Offenses under the Copyright Act, 1957

S. No.	Offences under the Copyright Act	Punishment
1.	Section 63 Intentional infringement or abetment of the infringement of the copyright in a work.	Imprisonment for a term which shall not be less than six months and may extend to three years and with fine which shall not be less than fifty thousand rupees but which may extend to two lakh rupees.
2.	Section 63A Second and subsequent convictions	Imprisonment for a term which shall not be less than one year but which may extend to three years and with fine which shall not be less than one lakh rupees but which may extend to two lakh rupees
3.	Section 63B Knowing use of infringing copy of computer program	Imprisonment for a term which shall not be less than seven days but which may extend to three years and with fine which shall not be less than fifty thousand rupees but which may extend to two lakh rupees.

S. No.	Offences under the Copyright Act	Punishment
4.	Section 65 Possession of plates for purpose of making infringing copies	Imprisonment which may extend to two years and shall also be liable to fine.
5.	Section 65A Protection of technological measures	Imprisonment which may extend to two years and shall also be liable to fine.
6.	Section 65B Protection of Rights Management Information	Imprisonment which may extend to two years and shall also be liable to fine.
7.	Section 67 Penalty for making false entries in register for producing or tendering false entries	Imprisonment which may extend to one year or with fine or both.
8.	Section 68 Penalty for making false statements for the purpose of deceiving or influencing any authority or officer	Imprisonment which may extend to one year or with fine or both.
9.	Section 68A Penalty for contravention of Section 52A (particulars to be included in Sound Recordings and Video films)	Imprisonment which may extend to three years and shall also be liable to fine.
10.	Section 69 Offences by Companies	In case an offence under the Copyright Act is committed by a company or a partnership firm, all directors, partners, managers, secretaries etc. who are responsible for the conduct of the business of the said company/partnership firm shall be guilty of such offence along with the company/partnership firm as the case may be. However, such persons shall not be liable if they prove that they exercised all due diligence to prevent the commission of such offence or it was committed without their knowledge.

6. Classification of Offences under the Code of Criminal Procedure, 1973:

Schedule 1 of the Code of Criminal Procedure, 1973 lays down the classification of the offences as cognizable or non-cognizable offences. IP Crimes fall under Part II of Schedule 1, which deals with “offences under other laws”.

Offence	Cognizable/Non-Cognizable	Bailable/Non-Bailable	Court Triable
If punishment with death, imprisonment for life or imprisonment for more than 7 years	Cognizable	Non-Bailable	Court of session
If punishable for imprisonment for 3 years and upwards but not more than 7 years.	Cognizable	Non-Bailable	Magistrate of the first class
If punishable with imprisonment for less than 3 years or with fine only.	Non-Cognizable	Bailable	Any Magistrate

7. Criminal offences under the Indian Penal Code, 1860

There are several offences under the Indian Penal Code, 1860 which are in addition to the prescribed Trade Mark / Copyright offences and which should be considered along with the IP crimes being registered by enforcement agencies. Some of these are enumerated below:

Offence	Punishment	Nature of the Offence	Applicability
Section 107: Abetment of a thing A person is said to be abetting the doing of a thing if he: <ul style="list-style-type: none"> • Instigates a person to do that thing; • Engages with one or more other person or persons in 	Section 109: Punishment for abetment of a thing Whoever abets any offence shall be punished with the punishment provided for that offence.	Whether Cognizable/ Bailable will depend on the offence of which there was a abetment	To any IP Crime

Offence	Punishment	Nature of the Offence	Applicability
<p>any conspiracy for the doing of that thing, if an act or illegal omission takes place in pursuance of that conspiracy, and in order to the doing of that thing; or</p> <ul style="list-style-type: none"> ● Intentionally aids, by any act or illegal omission, the doing of that thing 			
<p>Section 120A: Definition of criminal conspiracy</p> <p>When two or more persons agree to do or cause to be done and illegal act or an act which is not illegal but is done by illegal means, such an agreement is designated as a criminal conspiracy.</p>	<p>Section 120B: Punishment for criminal conspiracy</p> <ul style="list-style-type: none"> ● Whoever is a party to a criminal conspiracy to commit an offence punishable with death, [imprisonment for life] or rigorous imprisonment for a term of two years or upwards, shall, where no express provision is made in this Code for the punishment of such a conspiracy, be punished in the same manner as if he had abetted such offence. ● A party to a criminal conspiracy other than for the offences mentioned above shall be punished with an imprisonment of six months, fine or both 	<p>Whether Cognizable/ Bailable will depend on the offence of which there was a criminal conspiracy</p>	<p>To any IP Crime</p>
<p>Section 177: Furnishing false information</p> <p>Whoever, being legally bound to furnish information on any subject to any public servant, as such, furnishes, as true, information on the subject</p>	<p>Section 177: Punishment for furnishing false information</p> <p>Imprisonment for a term which may extend to six months,</p>	<p>Non-Cognizable and Bailable</p>	<p>To any IP Crime</p>

Offence	Punishment	Nature of the Offence	Applicability
which he knows or has reason to believe to be false	or with fine which may extend to one thousand rupees, or with both; or, if the information which he is legally bound to give respects the commission of an offence, or is required for the purpose of preventing the commission of an offence, or in order to the apprehension of an offender, with imprisonment of either description for a term which may extend to two years, or with fine, or with both.		
Section 204: Destruction of document to prevent its production as evidence Whoever secretes or destroys any [document or electronic record] which he may be lawfully compelled to produce as evidence in a Court of Justice, or in any proceeding lawfully held before a public servant, as such, or obliterates or renders illegible the whole or any part of such [document or electronic record] with the intention of preventing the same from being produced or used as evidence before such Court or public servant as aforesaid, or after he shall have been lawfully summoned or required to produce the same for that purpose.	Section 204: Punishment for destruction of document to prevent its production as evidence Imprisonment of either description for a term which may extend to two years, or with fine, or with both.	Non-Cognizable and Bailable	To any IP Crime
Section 206: Fraudulent removal or concealment of property to prevent its seizure Whoever fraudulently removes, conceals, transfers or delivers	Section 206: Punishment for fraudulent removal or concealment of property to prevent its seizure	Non-Cognizable and Bailable	To any IP Crime

Offence	Punishment	Nature of the Offence	Applicability
to any person any property or any interest therein, intending thereby to prevent that property or interest therein from being taken as a forfeiture or in satisfaction of a fine, under a sentence which has been pronounced, or which he knows to be likely to be pronounced, by a Court of Justice or other competent authority, or from being taken in execution of a decree or order which has been made, or which he knows to be likely to be made by a Court of Justice in a civil suit	Imprisonment of either description for a term which may extend to two years, or with fine, or with both.		
Section 378: Theft Whoever, intending to take dishonestly any moveable property out of the possession of any person without that person's consent, moves that property in order to such taking, is said to commit theft.	Section 379: Punishment for theft Imprisonment of either description for a term which may extend to three years, or with fine, or with both.	Cognizable and Non-Bailable, Non-compoundable	Applicable only in relation to Television Signal Piracy by Distribution Platforms such as Cable/ DTH/ HITS / IPTV Service Provider as the Cable Signals that are pirated are the original signals deemed to be in the possession of the owner of the signals as against other industries where it is counterfeiting and/or copying.
Section 405: Criminal Breach of Trust Whoever, being in any manner entrusted with property, or with any dominion over property, dishonestly misappropriates or converts to his own use that property, or dishonestly uses or disposes of that property in violation of any direction of law prescribing	Section 406: Punishment for Criminal breach of trust Imprisonment of either description for a term which may extend to three years, or with fine, or with both	Cognizable and Non-Bailable, Non-Compoundable	Applicable only to piracy of Television signals as there is an entrustment of signals of TV channels by broadcaster to Distribution Platform (Cable/DTH/HITS/

Offence	Punishment	Nature of the Offence	Applicability
<p>the mode in which such trust is to be discharged, or of any legal contract, express or implied, which he has made touching the discharge of such trust, or wilfully suffers any other person so to do, commits 'criminal breach of trust</p>			<p>IPTV) Service Provider, under a legal contract which lays down the terms of exploitation of the signals such as authorized area and authorized mode. Any retransmission of signals in breach of such terms will amount to criminal breach of trust.</p>
	<p>Section 409: Criminal Breach of Trust by Public Servant, or by Banker, Merchant* or Agent Whoever, being in any manner entrusted with property, or with any dominion over property in his capacity of a public servant or in the way of his business as a banker, merchant, factor, broker, attorney or agent, commits criminal breach of trust in respect of that property, shall be punished with [imprisonment for life], or with imprisonment of either description for a term which may extend to ten years, and shall also be liable to fine**</p>		<p>* A merchant is a person who buys in whole sale and sells in retail. Since a cable operator takes signals of TV channels in whole sale from the Broadcaster(s) and sells in retail to subscribers/ consumers falls within the definition of merchant ** in case of continued piracy despite registration of FIR and raid, the Police may use its powers under 41(1)(a) and(b), 140 and 151 to prevent the commission of the cognizable offence of cable piracy.</p>

Offence	Punishment	Nature of the Offence	Applicability
<p>Section 420: Cheating and dishonestly inducing delivery of property</p> <p>Whoever cheats and thereby dishonestly induces the person deceived to deliver any property to any person, or to make, alter or destroy the whole or any part of a valuable security, or anything which is signed or sealed, and which is capable of being converted into a valuable security.</p>	<p>Section 420:</p> <p>Punishment for cheating and dishonestly inducing delivery of property</p> <p>Imprisonment of either description for a term which may extend to seven years, and shall also be liable to fine.</p>	<p>Cognizable and Non-Bailable, Non – compoundable</p>	<p>To any IP Crime</p>
<p>Section 468: Forgery for the purpose of cheating</p> <p>Whoever commits forgery, intending that the [document or electronic record forged] shall be used for the purpose of cheating.</p>	<p>Section 468:</p> <p>Punishment for forgery for the purpose of cheating</p> <p>Imprisonment of either description for a term which may extend to seven years, and shall also be liable to fine.</p>	<p>Cognizable and Non-Bailable, Non – compoundable</p>	<p>To any IP Crime</p>
<p>Section 471: Using a genuine forged document</p> <p>Whoever fraudulently or dishonestly uses as genuine any [document or electronic record] which he knows or has reason to believe to be a forged [document or electronic record]</p>	<p>Section 471:</p> <p>Punishment for using a genuine forged document</p> <p>Punishment in the same manner as if he had forged such document or electronic record, which is</p> <p>Imprisonment of either description for a term which may extend to seven years, and shall also be liable to fine as per Section 468.</p>	<p>Cognizable and Bailable, Non – compoundable</p>	<p>To any IP Crime</p>
<p>Section 481: Using a false property mark</p> <p>Whoever marks any moveable property or goods or any case, package or other receptacle containing moveable property or goods, or uses any case,</p>	<p>Section 482:</p> <p>Punishment for using a false property mark</p> <p>Imprisonment of either description for a term which may extend to one year, or</p>	<p>Non- Cognizable, Bailable, compoundable</p>	<p>Applicable to Trademark offences</p>

Offence	Punishment	Nature of the Offence	Applicability
package or other receptacle having any mark thereon, in a manner reasonably calculated to cause it to be believed that the property or goods so marked, or any property or goods contained in any such receptacle so marked, belong to a person to whom they do not belong, is said to use a false property mark.	with fine, or with both		
Section 483: Counterfeiting a property mark used by another Whoever counterfeits any property mark used by any other person	Section 483: Punishment for counterfeiting a property mark used by another Imprisonment of either description for a term which may extend to two years, or with fine, or with both.	Non-Cognizable, Bailable, Compoundable	Applicable to Trademark offences
Section 484: Counterfeiting a mark used by a public servant: Whoever counterfeits any property mark used by a public servant, or any mark used by a public servant to denote that any property has been manufactured by a particular person or at a particular time or place, or that the property is of a particular quality of has passed through a particular office, or that it is entitled to any exemption, or uses as genuine any such mark knowing the same to be counterfeited.	Section 484: Punishment for counterfeiting a mark used by a public servant Imprisonment of either description for a term which may extend to three years, and shall also be liable to fine.	Bailable, Non-Cognizable, Non-Compoundable	Applicable to Trademark offences
Section 485: Making or possession of any instrument for counterfeiting a property mark Whoever makes or has in his possession any die, plate or other instrument for the	Section 485: Punishment for making or possession of any instrument for counterfeiting a property mark	Bailable, Non-Cognizable, Non-Compoundable	Applicable to Trademark offences

Offence	Punishment	Nature of the Offence	Applicability
purpose of counterfeiting a property mark, or has in his possession a property mark for the purpose of denoting that any goods belong to a person to whom they do not belong	Imprisonment of either description for a term which may extend to three years or with fine, or with both.		
Section 486: Selling goods marked with a counterfeit property mark Whoever sells, or exposes, or has in possession for sale, any goods or things with a counterfeit property mark] affixed to or impressed upon the same to or upon any case, package or other receptacle in which such goods are contained	Section 486: Punishment for selling goods with a counterfeit property mark Imprisonment of either description for a term which may extend to one year, or with fine, or with both.	Bailable, Non-Cognizable, Compoundable	Applicable to Trademark offences
Section 487: Making a false mark upon any receptacle containing goods Whoever makes any false mark upon any case, package or other receptacle containing goods, in a manner reasonably calculated to cause any public servant or any other person to believe that such receptacle contains goods which it does not contain or that it does not contain goods which it does contain, or that the goods contained in such receptacle are of a nature or quality different from the real nature or quality thereof, shall, unless he proves that he acted without intent to defraud	Section 487: Punishment for making a false mark upon any receptacle containing goods Imprisonment of either description for a term which may extend to three years, or with fine, or with both	Bailable, Non-Cognizable, Non-Compoundable	Applicable to Trademark offences
Section 488: Punishment for making use of any such false mark Whoever makes use of any such false mark in any manner prohibited by the last foregoing section shall, unless he proves that he acted without intent to defraud, be punished as if he had committed an offence against that section.	Section 488: Punishment for making use of any such false mark Imprisonment of either description for a term which may extend to three years, or with fine, or with both	Bailable, Non-Cognizable, Non-Compoundable	Applicable to Trademark offences

Offence	Punishment	Nature of the Offence	Applicability
<p>Section 489: Tempering with property mark with intent to cause injury</p> <p>Whoever removes, destroys, defaces or adds to any property mark, intending or knowing it to be likely that he may thereby cause injury to any person</p>	<p>Section 489: Punishment for tempering with property mark with intent to cause injury</p> <p>Imprisonment of either description for a term which may extend to one year, or with fine, or with both.</p>	<p>Bailable, Non-Cognizable, Non-Compoundable</p>	<p>Applicable to Trademark offences</p>
<p>The Police has no powers for site-blocking. This can only be done through an order of the competent Court.</p>			

8. Search and Seizure Power of Police in IP Crimes

S. No	Name of the Statute	Provision	Seizure Powers of Police
1.	Trade Marks Act, 1999	Section 115 (4) Cognizance of certain offences and the powers of police officer for search and seizure	<ul style="list-style-type: none"> Any police officer not below the rank of deputy superintendent of police or equivalent, may, if he is satisfied that any of the offences referred to in sub-section (3) has been, is being, or is likely to be, committed, search and seize without warrant the goods, die, block, machine, plate, other instruments or things involved in committing the offence, wherever found, and all the articles so seized shall, as soon as practicable, be produced before a Judicial Magistrate of the first class or Metropolitan Magistrate, as the case may be: Provided that the police officer, before making any search and seizure, shall obtain the opinion of the Registrar on facts involved in the offence relating to trade mark and shall abide by the opinion so obtained.
2.	Copyright Act, 1957	Section 64 Power of police to seize infringing copies	<ul style="list-style-type: none"> Where a magistrate has taken cognizance of any offence under section 63 in respect of the infringement of copyright in any work, it shall be lawful for any police officer, not below the rank of sub-inspector, to seize without any warrant from the magistrate, all copies of the work wherever found, which appear to him to

S. No	Name of the Statute	Provision	Seizure Powers of Police
			<p>be infringing copies of the work and all copies so seized shall, as soon as practicable, be produced before the magistrate.</p> <ul style="list-style-type: none"> Any person having an interest in any copies of a work seized under sub-section (1) may, within fifteen days of such seizure, make an application to the magistrate for such copies being restored to him and the magistrate, after hearing the applicant and the complainant and making such further inquiry as may be necessary, shall make such order on the application as he may deem fit.
3.	The Code of Criminal Procedure, 1973	<p>Section 41 When police may arrest without warrant</p> <p>- Since television channel piracy is usually a continuing offence it becomes necessary to arrest the accused and stop the commission of cognizable offence</p>	<p>(1) Any police officer may without an order from a Magistrate and without a warrant, arrest any person-</p> <p>(a) Who commits, in the presence of a police officer, a cognizable offence;</p> <p>(b) against whom a reasonable complaint has been received, or a reasonable suspicion exists, that he has committed a cognizable offence punishable with imprisonment for a term which may be less than seven years or which may extend to seven years whether with or without or without fine, if the following conditions are satisfied, namely:-</p> <p>(i) The police officer has reason to believe on the basis of such complaint, information, or suspicion that such person has committed the said offence;</p> <p>(ii) The Police officer is satisfied that such arrest is necessary</p> <p>(a) To prevent such person from committing any further offence; or</p> <p>(b) For proper investigation of the offence; or</p> <p>(c) To prevent such person from causing the evidence of the offence to disappear or tampering with such evidence in any manner; or</p> <p>(d) To prevent such person from making any inducement, threat or promise to any person acquainted with the facts of the case so to dissuade him from closing such facts to the court or to the police office; or</p> <p>(e) As unless such person is arrested, his presence in the court whenever required cannot be ensured; and the police officer shall record while making such arrest, his reason in writing</p>

S. No	Name of the Statute	Provision	Seizure Powers of Police
			<p>be infringing copies of the work and all copies so seized shall, as soon as practicable, be produced before the magistrate.</p> <ul style="list-style-type: none"> Any person having an interest in any copies of a work seized under sub-section (1) may, within fifteen days of such seizure, make an application to the magistrate for such copies being restored to him and the magistrate, after hearing the applicant and the complainant and making such further inquiry as may be necessary, shall make such order on the application as he may deem fit.
		<p>Section 140 Power of Magistrate to furnish written instructions, etc. - Police to prevent cognizable offences</p>	<p>Every police officer may interpose for the purpose of preventing, and shall, to the best of his ability, prevent, the commission of any cognizable offence.</p>
		<p>Section 151 CrPC Arrest to prevent the commission of cognizable offences</p>	<p>A police officer knowing of a design to commit any cognizable offence may arrest, without orders from a Magistrate and without a warrant, the person so designing, if it appears to such officer that the commission of the offence cannot be otherwise prevented.</p>
		<p>Section 165 Search by Police Officer</p>	<p>Whenever an officer in charge of a police station or a police officer making an investigation has reasonable grounds for believing that anything necessary for the purposes of an investigation into any offence which he is authorised to investigate may be found in any place with the limits of the police station of which he is in charge, or to which he is attached, and that such thing cannot in his opinion be otherwise obtained without undue delay, such officer may, after recording in writing the grounds of his belief and specifying in such writing, so far as possible, the thing for which search is to be made, search, or cause search to be made, for such thing in any place within the limits of such station.</p> <p>2. A police officer proceeding under sub-section (1), shall, if practicable, conduct the search in person - If he is unable to conduct the search in person, and there is no other</p>

S. No	Name of the Statute	Provision	Seizure Powers of Police
			<p>person competent to make the search present at the time, he may, after recording in writing his reasons for so doing, require any officer subordinate to him to make the search, and he shall deliver to such subordinate officer an order in writing, specifying the place to be searched, and so far as possible, the thing for which search is to be made; and such subordinate officer may thereupon search for such thing in such place.</p> <p>3. The provisions of this Code as to search-warrants and the general provisions as to searches contained in section 100 shall, so far as may be, apply to a search made under this section.</p> <p>4. Copies of any record made under sub-section (1) or sub-section (3) shall forthwith be sent to the nearest Magistrate empowered to take cognizance of the offence, and the owner or occupier of the place searched shall, on application, be furnished, free of cost, with a copy of the same by the Magistrate.</p>
		<p>Section 181 Place of trial in case of certain offences.</p>	<p>3) Any offence of theft*, extortion or robbery may be inquired into or tried by a Court within whose local jurisdiction the offence was committed or the stolen property which is the subject of the offence was possessed by any person committing it or by any person who received or retained such property knowing or having reason to believe it to be stolen property.</p> <p>(4) Any offence of criminal misappropriation or of criminal** breach of trust may be inquired into or tried by a Court within whose local jurisdiction the offence was committed or any part of the property which is the subject of the offence was received or retained, or was required to be returned or accounted for, by the accused person.</p> <p>*Piracy of TV channels by an unauthorised cable operator in theft</p> <p>** Piracy by authorised cable operator is criminal breach of trust of TV channels</p>

S. No	Name of the Statute	Provision	Seizure Powers of Police
4.	The Cable Television Networks (Regulations) Act, 1995	Section 11 Power to seize equipment used for operating the cable television network	Section 11 <ul style="list-style-type: none"> If any authorized officer has reason to believe that provisions of section 3, section 4A, Section 5, Section 6, section 8, section 9, section 10 have been or are being contravened by any cable operator, he may seize the equipment being used by such cable operator for opening the Cable Television Network Provided that the seizure of equipment in case of contravention of section 5 and 6 shall be limited to the programming service provided on the channel generated at the level of cable operator
		Section 12 Confiscation	Section 12 The equipment seized under sub-section (1) of section 11 shall be liable to confiscation unless the cable operator from whom the equipment has been seized registers himself as a cable operator under section 4 within a period of thirty days from the date of seizure of the said equipment
5.	Information Technology Act, 2000	Section 76 Confiscation	Section 76 Any computer, computer system, floppies, compact disks, tape drives or any other accessories related thereto, in respect of which any provision of this Act. rules, orders or regulations made thereunder has been or is being contravened, shall be liable to confiscation
		Section 77 Penalties or confiscation not to interfere with other punishments	Section 77 No penalty imposed or confiscation made under this Act shall prevent the imposition of any other punishment to which the person affected thereby is liable under any other law for the time being in force.
		Section 78 Power to investigate offences	Section 78 Notwithstanding anything contained in the Code of Criminal Procedure, 1973, a police officer not below the rank of Deputy Superintendent of Police shall investigate any offence under this Act.

S. No	Name of the Statute	Provision	Seizure Powers of Police
6.	Customs Act, 1962 ³	Section 11 Power to prohibit importation or exportation of goods	Section 11 <ul style="list-style-type: none"> The Section 11 of the Customs Act, 1962 enables Customs authority to prohibit either absolutely or subject to such conditions (to be fulfilled before or after clearance) as may be specified in the notification, the import or export of goods of any specified description. Section 11 (2) (n); the protection of patents, trademarks, copyrights, designs and geographical indications
7.	Cinematograph Act, 1952	Section 7A Power of Seizure	Section 7A <ul style="list-style-type: none"> Where a film in respect of which no certificate has been granted under this Act is exhibited, or a film certified as suitable for public exhibition restricted to adults is exhibited to any person who is not an adult or a film is exhibited in contravention of any of the other provisions contained in this Act or of any order made by the Central Government or the Board in the exercise of any of the powers conferred on it, any police officer may enter any place in which he has reason to believe that the film has been or is being or is likely to be exhibited, search it and seize the film. The search is to be carried out as per the relevant provisions of CrPc.

³ In order to efficiently control the import of infringing goods, the Intellectual Property Rights (Imported Goods) Enforcement Rules, 2007 were introduced. Under these Rules, an application along with a general bond and an indemnity bond need to be submitted by the copyright holder with the customs authorities. Once the application is fixed, a Unique Permanent Registration Number (UPRN) number is allotted to the copyright holder which is valid for a period of 5 years. On his satisfaction as to the ownership of rights in such goods, the Commissioner has the power to detain such goods. It should be noted that the Commissioner has the power to release all such detained goods (in the event of a challenge against the detention by the importer) if the right-holder does not produce before him, any order from a Court of competent jurisdiction as to the temporary or permanent disposal of the detained goods within fourteen days from the date on which the goods were detained

Chapter 2

GENERAL GUIDELINES FOR SEARCH AND SEIZURE

- 1) Immediate or expeditious execution of search and seizure action is imperative to effectively address piracy. Given the covert nature of piracy, acting immediately on information on piracy is critical and any delay will likely defeat the purpose;
- 2) In all types of arrest, search and seizure, the provisions of the Criminal Procedure Code read with section 115 of Trademark Act, 1999 or any other specific provision as the case may be and the precautions pronounced by the Hon'ble Court must be followed to avoid the procedural lacunae.
- 3) Search or seizure at any premises shall be conducted only by an officer of the rank not below the Deputy Superintendent of Police or with relevant authority under him;
- 4) The concerned police officer conducting the search and seizure shall exercise all powers available to the police to effectuate the search and seizure including lock breaking powers;
- 5) Search/seizure shall be conducted as per prescribed procedure and reasons for doing so by the concerned police officer as informed by the contents of complaint made by complainant;
- 6) Search and Seizure actions should be conducted in premises identified by the complainant as well as at any other premises subsequently identified during course of investigation and action;
- 7) Police officers shall seek to secure the presence of the owner of the entity/shop/house premises, employees and official panch witnesses at the time of conducting such search/seizure and also obtain the signatures of the owner of the shop, the landlord of the

premises if available, employees if present and the panch witnesses therein;

- 8) Linking owner with location of infringement- The concerned police officer shall also obtain copies of the licenses issued by the municipality/corporation to operate the shop/entity. Any rent deed/leave and license agreement shall also be obtained from the premises, if available.
- 9) The shop owner should be examined. The statements of the owner of the premises shall also be recorded under section 161 of Code of Criminal Procedure;
- 10) The concerned officer shall take due care to ascertain and obtain all the evidences available at the premises during the time of search and seizure and prepare an inventory thereof for the purpose of record and preserve them for the future references.
- 11) All accounts books, financial details, receipt books, payment slips etc. should be seized to preserve evidence of money laundering of proceeds from IP crimes;
- 12) In case of disclosures by accused of additional premises/ details of infringing activity, these should be recorded and immediately/ expeditiously followed up by search and seizure on those premises also;
- 13) Police officers should call upon two or more independent and respectable inhabitants of the locality in which the place to be searched is situated. The search must be conducted in the presence of such witnesses as per Section 100 (4) of the CrPC;
- 14) As per Section 160, 161 and 162 of the CrPC, if the investigating officer considers it necessary, he may order in writing, attendance of witnesses residing within the limits of his own or adjoining police stations and examine such witnesses. Statement of such witness, if reduced in writing, need not be signed by the person making it;

- 15) Acknowledgment shall be given to the accused/owner of the premises where search or seizure was conducted of the copy of the panchnama together with all other annexures. The description of place of offence should be mentioned in panchnama;
- 16) List of seized articles should be furnished to the accused under Section 165 of the CrPC;
- 17) The search and seizure proceedings shall be covered through videography and the statement of the videographer shall be reduced to writing and recorded in detail under Section 161 of Code of Criminal Procedure at the cost of the complainant;
- 18) In cases of video or audio or book piracy, the investigating officer may, if necessary, inspect the home premises of the owner of the shop/entity;
- 19) Photographs of the premises/shop should be taken while the accused is carrying on the business;
- 20) Photographs of the premises, book shop or any other entity involved in video/audio/book piracy should be taken;
- 21) Seizure of all infringing products available in the premises is imperative. A list of items to be seized is provided in the accompanying checklist.
- 22) The concerned police officer shall have an account of the number of such confiscated infringing products and apparatus and shall get the signature of the owner of the shop while removing it from the premises of the shop;
- 23) Police officers shall secure identification of infringing material from complainant and record such statement accordingly after completion of search and seizure;

- 24) All digital / electronic material seized during a search and seizure material should be carefully sealed for validation by State/ Central Forensics Laboratory;
- 25) "Mirror copies" of digital/ electronic evidence should be immediately made to preserve evidence and to send to State/ Central Forensics Laboratory;
- 26) All the properties or infringing products seized, which shall include the infringing copies, plates, broadcasting equipment, other accessories involved in relaying/ exploiting/manufacturing/ producing the infringing copies including laptop or hard disk of machine on which video/audio/ infringing material was found to be residing/installed/ duplicated and all other products seized during the course of search and seizure shall be neatly and safely packed, sealed and shall be produced before the magistrate as earlier as possible without any lapse of time;
- 27) Challan should be filed before the competent magistrate as per the provisions of the Section 173 of the Code of Criminal Procedure, 1973 within the specified period, i.e., within 60 or 90 days as the case may be.

Chapter 3

CHECKLIST FOR REGISTERING COMPLAINT

It is mandatory to register an FIR if the information given to the police discloses the commission of a cognizable offence.

- *Lalita Kumari vs. Govt. of U.P. and Ors., AIR 2014 SC 187*

IMPORTANT NOTE: There are three kinds of proof to be checked while registering a complaint – (a) proof of authority to institute complaint, (b) proof of current holder of right and (c) evidence of infringement.

COMPLETE ALL THREE SECTIONS.

SECTION ONE: PROOF OF AUTHORITY TO INSTITUTE COMPLAINT

If Indian Company

- Copy of Certificate of Registration from RoC/MCA, and
- Power of Attorney in favour of the person lodging the complaint, if complaint not made by the original right holder (duly notarized copy)

If foreign IP owner

- Duly attested copy of power of attorney legalized/*apostiled* under the Hague Convention

Additionally,

If the complainant is a further delegate authorized by the Power of Attorney holder,

- Delegation letter in favour of the person who is lodging the complaint, from the authorized person

No other document is required as proof of authority to institute a complaint for registration of an FIR.

Advisory:

- (i) Power of attorney can contain a photograph of the holder of power of attorney from the rights owner to ensure that such document is not misused.
- (ii) Holder of power of attorney/ delegate should produce valid ID proof to prevent misuse of Power of attorney, such as election ID card, PAN card, Driver's license, Passport copy, etc.

Registration of Power of attorney is not required for enforcement actions.

SECTION TWO: PROOF OF CURRENT HOLDER OF RIGHT

- If licensee/ assignee: copy of the license/ assignment agreement with original right holder

A. For Copyright Infringement

Copyright registration is not required under the Copyright Act, 1957 to enable protection under the Act. – K.C. Bokadia And Anr. vs Dinesh Chandra Dubey 1999 (1) MPLJ 33; Glaxo Orthopaedic U.K. Ltd. vs. Samrat Pharma, AIR 1984 Delhi 265

- Copyright registration certificate issued by the Registrar of Copyrights if available

For Cinematograph Film:

- Copy of the Certificate granted by Central Board of Film Certification (CBFC) under Section 5A of the Cinematograph Act, 1952,

OR

- Copy of published film with particulars displayed on it. The following particulars are legally required to be present on the video film: name and address of the person who has made the

film, name and address of the copyright owner and year of first publication.

For Sound Recording:

- Copy of the Certificate granted by Central Board of Film Certification (CBFC) under Section 5A of the Cinematograph Act, 1952,

OR

- Copy of published sound recording with particulars displayed on it. The following particulars are legally required to be present on the sound recording: name and address of the person who has made the recording, name and address of the copyright owner and year of first publication.

For Computer Program:

- Notarized Copies of Copyright Registration Certificate [Indian/ US/ other Berne Convention Country registration will suffice],

AND

- In case of off-the-shelf-software: copy of Original Software Package with Copyright Owner/Publisher's name disclosed on package,

AND

- End User License Agreement (EULA)/Software licensing agreement,

AND

- Report generated by a technical expert duly authorized and trained by the software manufacturer to identify the original software from the pirated software

For Books/ Magazines/ Journals and other printed materials:

- Copy of original book bearing publisher's name,

AND

- Copy of agreement with original publisher if complainant publisher is different,

OR

- Attested copy of author-publisher agreement

In case of a literary (including computer programs), dramatic, musical or artistic work or a cinematographic film or a sound recording, the person whose name appears on copies of the work purporting to be that of the author/ publisher is PRESUMED TO BE the actual author/ publisher, in any proceeding in respect of infringement of copyright, unless the contrary is proved. – Section 55(2), Copyright Act

B. For Trademark Infringement

- “Certificate for Use in Legal Proceedings” pertaining to the Trade Mark Registration asserted by IP owner

Advisory: Trade Mark Registration Certificate does not reflect current status of the mark and should not be accepted as sufficient proof of ownership.

A. Broadcast Reproduction Right (for cable signal piracy)

- Up-linking / Down linking permission granted to TV Channel Owner

OR

- Agreement of a Broadcaster with any cable / DTH operator anywhere in India

SECTION THREE: EVIDENCE OF INFRINGEMENT

1. Whether any infringing items produced – tick any one:

Yes

No

2. If Yes -

List of items produced along with any details provided:

1.

2.

3.

4.

5.

Source from where infringing items obtained: _____

Proof of purchase of infringing copies

Video recording or digital/electronic evidence of piracy along with the complaint should be accepted as basis for registration of the FIR. Such electronic evidence is admissible under section 65B of the Evidence Act.

Admissibility of electronic evidence under Section 65B: *Anvar P.V. v. P.K. Basheer and ors.*, (AIR 2015 SC 180) -

“Any information contained in an electronic record which is printed on a paper, stored, recorded or copied in optical or magnetic media produced by a computer shall be deemed to be a document only if the conditions mentioned under sub-Section (2) are satisfied, without further proof or production of the original. The very admissibility of such a document, i.e., electronic record which is called as computer output, depends on the satisfaction of the four conditions under Section 65B(2). Following are the specified conditions under Section 65B(2) of the Evidence Act:

(i) The electronic record containing the information should have been produced by the computer during the period over which the same was regularly used to store or process information for the purpose of any activity regularly carried on over that period by the person having lawful control over the use of that computer;

- (ii) The information of the kind contained in electronic record or of the kind from which the information is derived was regularly fed into the computer in the ordinary course of the said activity;
- (iii) During the material part of the said period, the computer was operating properly and that even if it was not operating properly for some time, the break or breaks had not affected either the record or the accuracy of its contents; and
- (iv) The information contained in the record should be a reproduction or derivation from the information fed into the computer in the ordinary course of the said activity.

Under Section 65B(4) of the Evidence Act, if it is desired to give a statement in any proceedings pertaining to an electronic record, it is permissible provided the following conditions are satisfied:

- (a) There must be a certificate which identifies the electronic record containing the statement;
- (b) The certificate must describe the manner in which the electronic record was produced;
- (c) The certificate must furnish the particulars of the device involved in the production of that record;
- (d) The certificate must deal with the applicable conditions mentioned under Section 65B(2) of the Evidence Act; and
- (e) The certificate must be signed by a person occupying a responsible official position in relation to the operation of the relevant device.

It is further clarified that the person need only to state in the certificate that the same is to the best of his knowledge and belief. Most importantly, such a certificate must accompany the electronic record like computer printout, Compact Disc (CD), Video Compact Disc (VCD), pen drive, etc., pertaining to which a statement is sought to be given in evidence, when the same is produced in evidence. All these safeguards are taken to ensure the source and authenticity, which are the two hallmarks pertaining to electronic record sought to be used as evidence. Electronic records being more susceptible to tampering, alteration, transposition, excision, etc. without such safeguards, the whole trial based on proof of electronic records can lead to travesty of justice.”

(paras 13, 14, 15)

Chapter 4

CHECKLIST FOR SEARCH AND SEIZURE

IMPORTANT NOTE: COMPLETE ALL FOUR SECTIONS.

SECTION ONE: DOCUMENTS TO BE GIVEN TO THE ACCUSED/OWNER OF THE PREMISES WHERE SEARCH OR SEIZURE WAS CONDUCTED

- Acknowledgment
- Copy of the panchnama containing a description of place of offence together with all other annexures
- List of seized articles, as per Section 165 of the CrPC

SECTION TWO: DOCUMENTS SEIZED FROM THE ACCUSED/ OWNER

- Copies of the licenses issued by the municipality/ corporation to operate the shop/entity
- Any other rent deed/leave and license agreement
- Any other document(s) – please specify: _____

SECTION THREE: PROCEDURES FOLLOWED WHILE CONDUCTING SEARCH

- Owner of the entity/shop/house premises searched present
- Signature of owner taken
- Shop owner examined
- Number of employees present: _____
- Signatures of employees taken
- Any other witnesses present: _____
- Signatures of witnesses taken
- Photographs of the premises being searched

- Photograph of the premises/shop taken while the accused is carrying on the business
- Proceedings recorded through videography
- Statements of videographer reduced to writing at cost of complainant as per Section 161 of the CrPC
- For video/ audio/ book piracy: Home of the shop owner visited
- Statement of complainant recorded AFTER completion of search and seizure
- Digital/ electronic material seized sealed for validation by State/ Central Forensics Laboratory
- “Mirror copies” of digital/ electronic evidence made
- Seized items packed, sealed and produced before Magistrate
- Challan filed before the competent magistrate as per Section 173 of the CrPC

SECTION FOUR: LIST OF INFRINGING ITEMS SEIZED

I. For trade mark counterfeiting:

- Products packaged with infringing labels
- Loose infringing labels
- Artwork for infringing labels
- Any other items: _____

Printing apparatus, plates etc. used to make, produce, manufacture and effectuate infringing material and acts:

- Printers
- Computers
- Hard discs
- Any other items: _____

II. For software, films & sound recording piracy:

- | | |
|--|---|
| <input type="checkbox"/> Infringing/ pirated software | <input type="checkbox"/> RAM |
| <input type="checkbox"/> Video/audio cassettes | <input type="checkbox"/> Graphic card |
| <input type="checkbox"/> DVDs/CDs | <input type="checkbox"/> HD recording devices |
| <input type="checkbox"/> Computer hard disks | <input type="checkbox"/> DVD copier |
| <input type="checkbox"/> Laptops | <input type="checkbox"/> Scanner |
| <input type="checkbox"/> USBs | <input type="checkbox"/> Software converter |
| <input type="checkbox"/> Server/s including remote desktop servers | <input type="checkbox"/> External DVD writers |
| <input type="checkbox"/> Mobile phones | <input type="checkbox"/> Any other items: |
| <input type="checkbox"/> Hi-tech desktop system | _____ |

Printing apparatus, plates etc. used to make, produce, manufacture and effectuate infringing material and acts:

- | | |
|---|---|
| <input type="checkbox"/> Computers | <input type="checkbox"/> Hi-tech desktop system |
| <input type="checkbox"/> CD burners | <input type="checkbox"/> RAM |
| <input type="checkbox"/> Desktops or servers including remote desktop servers | <input type="checkbox"/> Graphic card |
| <input type="checkbox"/> Laptops | <input type="checkbox"/> HD recording devices |
| <input type="checkbox"/> Hard discs | <input type="checkbox"/> DVD copier |
| <input type="checkbox"/> USBs used to reproduce/ copy software/content | <input type="checkbox"/> Scanner |
| <input type="checkbox"/> Mobile phones | <input type="checkbox"/> Software converter |
| | <input type="checkbox"/> External DVD writers |
| | <input type="checkbox"/> Any other items: |
| | _____ |

III. For cable piracy:

ALL Printing apparatuses, plates etc. used to make, produce, manufacture and effectuate infringing material and acts:

- Computers
- Hard discs storing, cataloguing and scheduling dissemination of programme/ signals to subscribers, such as:
 - DTH Consumer Set Top Box
 - DTH Antenna along with Low Noise Block down converter with Feed pipe (LNBF)
 - HITS consumer Set Top Box
 - MSO consumer Set Top Box
 - Any other source of piracy - Dream Set Top Box/ Magic Set Top Box
 - IPTV Streaming Set Top Box
- Any other items: _____

Medium/ signal processing units, such as:

- | | |
|---|--|
| <input type="checkbox"/> Modulator in case of analogue transmission | <input type="checkbox"/> Network Switch |
| <input type="checkbox"/> Mixer/ combining unit in case of analogue transmission | <input type="checkbox"/> Optical transmitter |
| <input type="checkbox"/> Encoder | <input type="checkbox"/> Optical Receiver (NODE) |
| <input type="checkbox"/> EDGE QAM/ IP QAM (Mixing, scrambling and QAM) | <input type="checkbox"/> Cable – Coaxial and/or Fiber Optics |
| <input type="checkbox"/> NMS - Network Management System along with display unit - Computer Monitor, Lap Top, iPad etc. | <input type="checkbox"/> Signal Amplification Device – Amplifier |
| | <input type="checkbox"/> Any other items: _____ |

IV. For book piracy:

- Infringing copies of books
 - Book cover jackets
 - Art work for book covers
 - Any other items:
-

Printing apparatus, plates etc. used to make, produce, manufacture and effectuate infringing material and acts:

- Photo copying machines
 - Screen printing apparatus
 - Any other items:
-

V. For evidence of money laundering from IP crimes:

- Accounts books
 - Financial details
 - Receipt books
 - Payment slips
 - Any other items:
-

ANNEXURES

ANNEXURE I

SAMPLE FORMS

1. Certificate of Incorporation of Indian Company



प्रारूप 1 पंजीकरण प्रमाण-पत्र

कॉर्पोरेट पहचान संख्या :

2009 - 2010

में एतद्वारा सत्यापित करता हूँ कि मैसर्स

का पंजीकरण, कम्पनी अधिनियम 1956 (1956 का 1) के अर्तगत आज किया जाता है और यह कम्पनी प्राइवेट लिमिटेड है।

यह निगमन-पत्र आज दिनांक तेरह मार्च दो हजार दस को मेरे हस्ताक्षर से दिल्ली में जारी किया जाता है।

Form 1 Certificate of Incorporation

Corporate Identity Number :

2009 - 2010

I hereby certify that is this day incorporated under the Companies Act, 1956 (No. 1 of 1956) and that the company is private limited.

Given under my hand at Delhi this Thirteenth day of March Two Thousand Ten .

उप कम्पनी रजिस्ट्रार / Deputy Registrar of Companies
राष्ट्रीय राजधानी क्षेत्र दिल्ली एवं हरियाणा
National Capital Territory of Delhi and Haryana

कम्पनी रजिस्ट्रार के कार्यालय अभिलेख में उपलब्ध पत्राचार का पता :
Mailing Address as per record available in Registrar of Companies office:

2. Copyright Registration Certificate



Extracts from the Register of Copyrights

1. Registration Number : [REDACTED]
 2. Name, address and nationality of the applicant : [REDACTED]
 3. Nature of the applicant's interest in the copyright of the work : AUTHOR
 4. Class and description of the work : LITERARY/ DRAMATIC WORK
 5. Title of the work : [REDACTED]
 6. Language of the work : ENGLISH
 7. Name, address and nationality of the author and if the author is deceased, date of his decease : [REDACTED]
 8. Whether the work is published or unpublished : PUBLISHED
 9. Year and country of first publication and name, address and nationality of the publisher : [REDACTED]
 10. Years and countries of subsequent publications, if any, and names, addresses and nationalities of the publishers : [REDACTED]
 11. Names, addresses and nationalities of the owners of various rights comprising the copyright in the work and the extent of rights held by each, together with particulars of assignments and licences, if any : [REDACTED]
 12. Names, addresses and nationalities of other persons, if any, authorised to assign or licence of rights comprising the copyright : [REDACTED]
 13. If the work is an 'Artistic work', the location of the original work, including name, address and nationality of the person in possession of the work. (In the case of an architectural work, the year of completion of the work should also be shown). : N.A.
 14. If the work is an 'Artistic work', whether it is registered under the Designs Act 2000 if yes give details. : N.A.
 15. If the work is an 'Artistic work', capable of being registered as a design under the Designs Act 2000, whether it has been applied to an article though an industrial process and, if yes, the number of times it is reproduced. : N.A.
 16. Remarks, if any : [REDACTED]
- Diary Number : [REDACTED]
Date of Application : [REDACTED]
Date of Receipt : [REDACTED]

DEPUTY REGISTRAR OF COPYRIGHTS



3. Power of Attorney



उत्तर प्रदेश UTTAR PRADESH



SPECIAL POWER OF ATTORNEY

KNOW ALL MEN BY THESE PRESENTS that, Mr. _____ of
 a partnership firm having its office at _____
 is the Constituted Attorney for
 (hereinafter referred to as the “Company”) having its registered
 office at _____
 and Corporate office at _____

The Company is the sole and exclusive distributor of the Channels as annexed herewith, (collectively referred to as “Channels”) Channels in India and has the right to take remedial legal actions to curb any unauthorized access to and piracy of the said Channels.

_____ hereby constitutes

_____ as its true and lawful Attorney to take all necessary remedial legal actions, including lodging, filing, on its behalf, First Information Report with the concerned police stations (‘FIR’) and/or complaint (Criminal) with the Judicial Courts (‘Complaint’), to curb unauthorized access and copyright violation of the said Channels anywhere through illegal hiring/ renting/trading/dealing/

(Signature)

selling/duplicating/ copying/ manufacturing/processing/ and/or exhibiting/ scanning/ playing unauthorized Video Cassette(s) VCDs /DVDs through Cable TV Networks or otherwise of the Programmes of above named Channels by

1. _____ of _____ located at _____; (and /or _____ its proprietors, link operators/ sub operators and /or franchisees).
2. And any person(s) acting in collusion and connivance with the aforesaid persons in the acts of illegal transmission, piracy, theft of cable signals of the company and criminal breach of trust or any other illegal act against the company.

_____ further authorizes said Mr.

_____ to take all necessary legal remedial actions, including the power to initiate and launch all criminal action proceedings under the Copyright Act, 1957, the Indian Penal Code, 1860 and other relevant acts and laws as amended, replaced, re-enacted or substituted from time to time and to lodge complaints with the police and / or other appropriate authorities and accompany the police and/or other law enforcement authorities for conducting raids and searches, to file papers, documents etc., and follow up with the relevant government/regulatory authorities including Police, Courts of Law as may be deemed necessary, to curb unauthorized access and piracy of the said Channels.

The content of this Power of Attorney shall be treated as confidential and the authority shall be exercised by the lawful Attorney for the purposes specified herein only. The lawful Attorney is not authorised to initiate or file proceedings under Section 156(3) of the Code of Criminal Procedure, 1973.

This Special Power of Attorney will be effective from the date hereof up to 21st September, 2016.

Place: Noida
Date: 22.07.2016

For _____

Constituted Attorney



ATTESTED
S.S. GUPTA, ADVOCATE
NOTARY PUBLIC
Delhi & Noida G.B. Nagar (U.P.)
R.S.No 5242
22 JUL 2016

5. TM Certificate for use in legal proceedings



भारत सरकार / GOVERNMENT OF INDIA
उद्योग विभाग / TRADE MARKS REGISTRY
कीर्तिका सड़क, भारत कॉलेज रोड, अंकोना 14, नवी दिल्ली-110075 फोन 28082915, 28082916, 28082917
Intellectual Property Division, Plot No.22, Sector 14, Dwarka, New Delhi-110075 Tel: 28082915, 28082916, 28082917



THE TRADE MARKS ACT, 1999.
(ACT 47 OF 1999)
(SECTION 137)
(FOR USE IN LEGAL PROCEEDINGS ONLY)
(as per data available on computer as on today.)

No. _____

In the matter of Registered No. _____ in
Class- 18

1516
16/9/2016

IT IS HEREBY CERTIFIED THAT

The annexure hereto is the True
copy/Photo copy of the entry in Register of
Trade Marks relating to Registered Trade
Marks No. _____ in Class- 18



RAJESH KUMAR OBEROI
Examiner of Trade Marks & GI
Govt. of India

(Authorized Under Section 3(2) of
the Trade Marks Act, 1999)

Dated this Thursday day of _____

(Disclaimer: The certified copy of the register is issued on the basis of computer data
as on to-day. If any discrepancy is noted, please contact immediately to up date the record)

TO



भारत सरकार / GOVERNMENT OF INDIA

उद्योग विज्ञान विभाग TRADE MARKS REGISTRY

केन्द्रीय कार्यालय: इण्डियन कॉन्सल बिल्डिंग, 32, देवरोड, 14, खाना बिल्डिंग-110075 फोन: 28082915, 28082916, 28082917
Intellectual Property Bhavan, Plot No 32, Sector 14, Dwarka, New Delhi-110075 Tel: 28082915, 28082916, 28082917



Trade Mark Application Number :

Office: DELHI

TradeMark NO :

Class :

Proprietor Details:

Name:

Category: Single Firm

Trading As :

Trade Description: MANUFACTURER & TRADERS

Proprietor Address:

Address For Service:

Country: India

Details:-

Registration Date :

Certificate No:

Certificate Date:

Renewal Date:

Registration Valid Upto:

Journal No :

Status:Registered

Used Since: Proposed to be used

Trade Mark Type:

Word Mark:

Goods & Descriptions:

HISTORY DATA:

REGISTRATION RENEWED FOR A PERIOD OF 10 YEARS FROM 14TH JANUARY, 1995 ADVERTISED IN JOURNAL NO. 1350

REGISTRATION RENEWED FOR A PERIOD OF 10 YEARS FROM 14TH JANUARY, 2005 ADVERTISED IN JOURNAL NO. 1350



6. US Copyright Registration for Software

 **Copyright Registration Certificate (17 U.S.C. 706)**

This Certificate issued under the seal of the Copyright Office in accordance with title 17, United States Code, attests that registration has been made for the work identified below. The information on this certificate has been made a part of the Copyright Office records.

Margybeth Peters
Register of Copyrights, United States of America

Registration Number _____
Effective date of registration: _____

Title _____
Title of Work: _____
Completion/ Publication _____
Year of Completion: 2008

Author _____
Author: _____
Author Created: computer program
Work made for hire: Yes
Domiciled in: United States

Copyright claimant _____
Copyright Claimant: _____

Limitation of copyright claim _____
Material excluded from this claim: computer program, Pending application for
Previous registration and year: _____
New material included in claim: computer program

Rights and Permissions _____
Organization Name: _____
Name: _____
Email: _____ Telephone: _____
Address: _____

Certification _____



APOSTILLE

(Convention de La Haye du 5 octobre 1961)

1. Country: United States of America

This public document

2. has been signed by _____

3. acting in the capacity of Register of Copyrights

4. bears the seal/stamp of U.S. Copyright Office, The Library of Congress

Certified

5. at Washington, D.C.

6. the _____

7. by *Assistant Authentication Officer, United States Department of State*

8. No. _____

9. Seal/Stamp:

10. Signature: _____

7. Permission to uplink TV channel from India

No.1404/90(ii)/2011-TV (I) *RS*
भारत सरकार
Government of India
सूचना और प्रसारण मंत्रालय
MINISTRY OF INFORMATION & BROADCASTING
'C' विंग, शास्त्री भवन, नई दिल्ली-110 001
'A' wing, Shastri Bhawan, New Delhi-110 001

Date:

To,
The Managing Director

Subject: Permission to uplink Non-news and Current Affairs TV channel namely "
from India

This is with reference to M/s. application dated 20.04.2011 seeking permission to uplink Non-news and Current Affairs TV channel from India and subsequent correspondence in this regard.

2. The undersigned is directed to convey permission to M/s to uplink Non-news & Current Affairs TV channel namely in language (in digital mode) through the teleport of located at using INSAT-2E satellite for a period of ten years, in accordance with the guidelines for Uplinking from India, notified on 02.12.2005, subject to the following:

- i) Compliance with terms & conditions contained in Annexure.
 - ii) Compliance with the undertakings given by the applicant company in the affidavits as in Form 1A and Form 1C dated during the period of validity of this permission.
 - iii) Condition that the company will not use uplinking facilities such as DSNG/SNG/RTTS/VSAT, etc. without prior approval of this Ministry.
 - iv) The company would be required to operationalise the channel within one year from the date of permission and intimate the same to this Ministry along with a copy of the WPC license.
3. Board of Directors namely are cleared from security angle.

Cont/-

SECURITY RELATED CONDITIONS

- i) The Licensing Authority shall be empowered to impose such restrictions as may be necessary as and when required.
- ii) The Licensing Authority shall have the power to revoke the licence on grounds of national security and public order.
- iii) The Licensing Authority shall have the power to prohibit transmission of programmes considered to be prejudicial to friendly relations with foreign governments, public order, security of state, communal harmony, etc.
- iv) Licence should provide access facilities of all equipment and records/ system to the Licensing Authority or its representative.
- v) Licence should make available detailed information about the equipment and its location.
- vi) Licensing Authority shall be legally competent to take over the stations on the occurrence of public emergency or in the interest of public safety/order.
- vii) Monitoring stations should be set up so as to facilitate prompt intervention for deterrent action against violations of technical parameters and provision laid down in the legislation and licensing agreements.
- viii) The Licensing Authority shall be empowered to modify the conditions laid down or incorporate any conditions as and when necessary in the interest of national security.
- ix) The applicant would make available to the Licensing Authority the detailed technical information about the equipments to be used.

1. 5/11

8. Registration Certificate to downlink TV channel into India

No.1404/90(II)/2011-TV (I)/24
भारत सरकार
Government of India
सूचना और प्रसारण मंत्रालय
MINISTRY OF INFORMATION & BROADCASTING
'ए' विंग, शास्त्री भवन, नई दिल्ली-110 001
'A' wing, Shastri Bhawan, New Delhi-110 001

Date:

To,
The Managing Director

REGISTRATION CERTIFICATE FOR DOWNLINKING OF TELEVISION CHANNEL INTO INDIA

Registration No.:

Subject: Permission to downlink Non-news & Current Affairs TV Channel

The undersigned is directed to refer to application dated 20.04.2011 and to convey registration of Non-news & Current Affairs TV channel namely in Malayalam language (in digital mode) through the teleport of located at using INSAT-2E satellite, for a period of 5 years for downlinking in to India to (applicant company), subject to the following conditions:

- i) The channel would seek fresh permission from the Government on completion of permission period of 5 years.
- ii) Compliance with terms and conditions contained in the Annexure.
- iii) The Channel shall comply with the Programme and Advertising Code prescribed under the Cable Television Networks (Regulation) Act, 1995 and Rules framed there under.
- iv) Compliance with the undertakings given by the applicant company in the affidavits as in form 1A and form 1B dated during the period of validity of this permission.
- v) The channel will be uplinked from India.

Under Secretary to Government of India
Tele# 23386125

-2-

4. _____ located at _____ are advised to approach WPC Wing, Ministry of Communications & IT for obtaining operational license/frequency approval in this regard. This permission is valid only if the company/teleport holds a valid WPC license for the channel.

Yours faithfully,

Under Secretary to Government of India
Tele: 23386125

Copy to:

_____ located at _____
You are required to comply with the terms & conditions laid down in the Teleport Licence Agreement entered with this Ministry while uplinking the said channel of _____

Under Secretary to Government of India

BASIC CONDITIONS/OBLIGATIONS

1. The applicant company shall adhere to any other code/Standards guidelines/restrictions prescribed by Ministry of Information & Broadcasting, Government of India for regulation of content on TV channels from time to time.
2. The applicant company shall obtain prior approval of the Ministry of I & B before undertaking any up gradation, expansion or any other changes in the downlinking and distribution system/network configuration.
3. The applicant company shall provide Satellite TV channel signal reception decoders only to MSOs/Cable operators registered under the Cable Television Networks (Regulation) Act 1995 or to a DTH operator registered under the DTH guidelines issued by Government of India.
4. The applicant company shall ensure that any of its channels, which is unregistered or prohibited from being telecast or transmitted or re-transmitted in India, under the Cable Television Networks (Regulation) Act 1995 or the DTH guidelines or any other law for the time being in force, cannot be received in India through encryption or any other means.
5. The Union Government shall have the right to suspend the permission of the company/registration of channel for a specified period in public interest in the interest of National security to prevent the misuse of the channel. The company shall immediately comply with any directives issued in this regards.
6. The applicant company seeking permission to downlinking a channel shall operationalise the channels within one year from the date of the permission being granted by the Ministry of I & B, failing which the permission will liable to be withdrawn without any notice in this regards. However, the company shall be afforded a reasonable opportunity of being heard before such a withdrawal.
7. The company/channel shall adhere to the norms, rules and regulations prescribed by any regulatory authority set up to regulate and monitor the Broadcast Services In the country.
8. The applicant company shall keep a record of programmes downlinked for a period of 90 days and to produce the same before any agency of the Government as and when required.
9. The applicant company shall furnish such information as may be required by the Ministry of I & B from time to time.
10. The applicant company shall provide the necessary monitoring facility at its own cost for monitoring of programmes or content by the representative of the Ministry of I & B or any other Government agency as and when required.
11. The applicant company shall comply with the obligations and conditions prescribed in the downlinking guidelines issued by the Ministry of I & B, and the specific downlinking permission agreement and registration of each channel.
12. In the event of any war, calamity/national security concerns, the Government shall have the power to prohibit for a specified period the downlinking/reception/transmission and re-transmission of any or all channels. The company shall immediately comply with any such directions issued in this regards.

No.1404/90(I)/2011-TV (I) / 19

भारत सरकार

Government of India

सूचना और प्रसारण मंत्रालय

MINISTRY OF INFORMATION & BROADCASTING

'A' wing, शास्त्री भवन, नई दिल्ली-110 001

'A' wing, Shastri Bhawan, New Delhi-110 001

साथीय

To,
The Managing Director

Subject: Permission for change of Name, logo, Teleport & satellite to downlink Non-news and Current Affairs TV channel into India.

Sir,
This is with reference to your letters dated _____ on the above subject.

2. In partial modification of this Ministry's letter of even no. dated _____, where in Non-news & current affairs TV channel '_____' was registered for downlinking into India the undersigned is directed to convey permission of this Ministry to _____ for the following changes for downlinking into India:

Changes	Old	New
Change of name of channel		
Change of Logo	OLD	New logo as submitted on _____ is accepted.
Change of Teleport		
Change of Satellite	INSAT-2E	INTELSAT-17

3. All other terms & conditions of this Ministry's letter dated _____ referred above, shall remain same.

Yours faithfully,

Under Secretary to Government of India
Tele # 23386125

ANNEXURE II

CABLE PIRACY OF PAY TV SIGNAL

FIG. 1:
Transmission of TV signal from Broadcaster to Subscriber

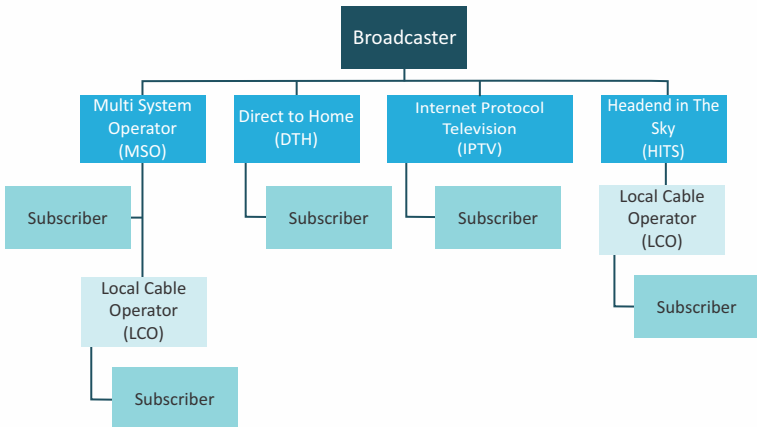
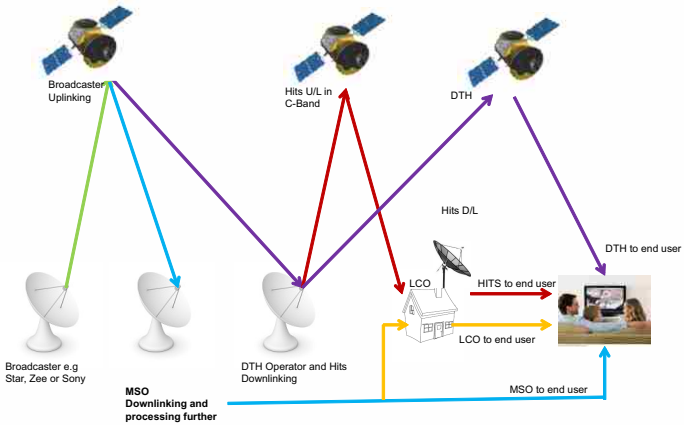

FIG 2:
Transmission of Pay TV channels in an ANALOGUE mode

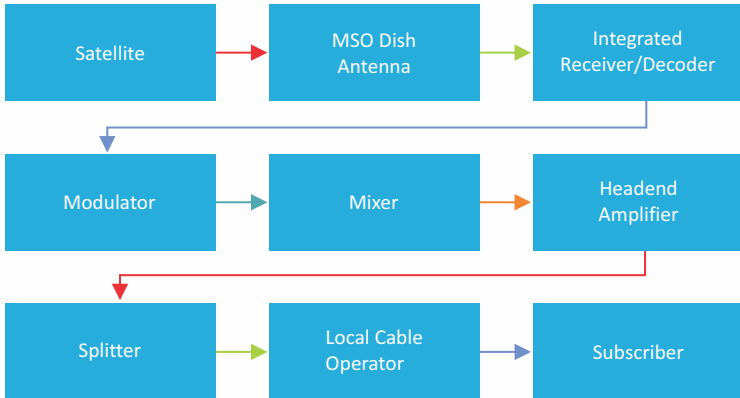

FIG 3:
Transmission of Pay TV channels in a DAS Area by MSO

FIG 3A: Directly to Subscriber

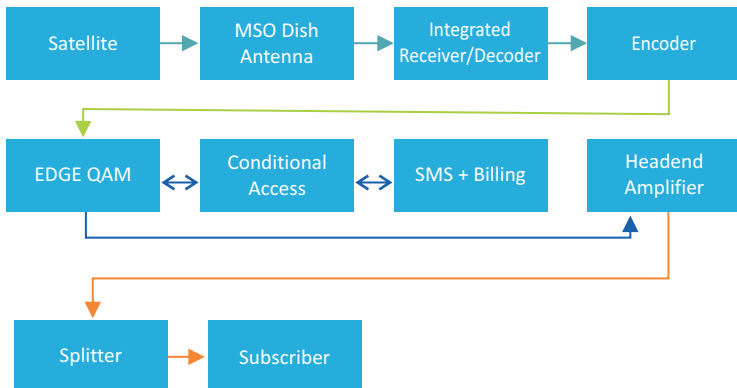
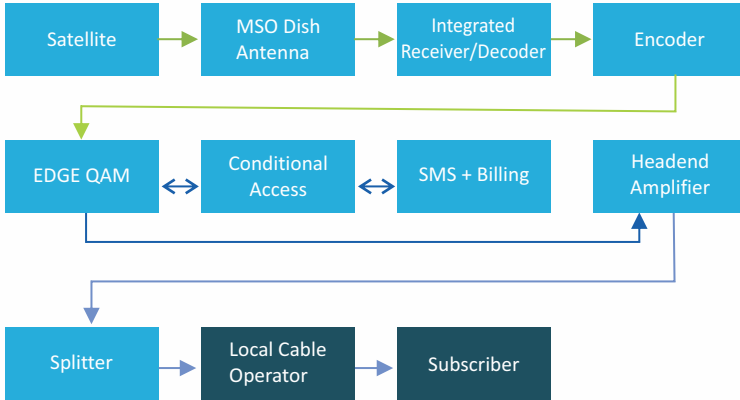

FIG 3B: Through LCOs



**FIG 4:
Hardware Used in Head End**



Integrated Receiver Decoder (IRD)

IRD is provided by Broadcaster. One IRD is used to transmit one channel only. Number of channels demonstrate number of IRDs at MSO Control Room.



Encoder

Encoder is used to convert Analog signal from IRDs into digital stream. 8 to 12 IRDs can be connected to one Encoder. Thus, one Encoder can carry 8 to 12 channels to form one stream.



EDGE QAM

Output of Encoder goes to input of EDGE QAM. One EDGE QAM can have 24 streams from 24 Encoders as input. EDGE QAM performs three functions: (1) Multiplexer- mixing of multiple streams from Encoders; (2) Scrambler – Scrambling in combination with CAS used to encrypt the streams from Encoders; (3) QAM – Decides the frequency/ Local Channel Number (LCN) of channel.



Amplifier

Amplifies the strength of the signal so that it can travel a longer distance.

Optical Transmitter

It converts electrical signal into optical signal so that it can travel a longer distance.

ANNEXURE III

Source To Online Piracy

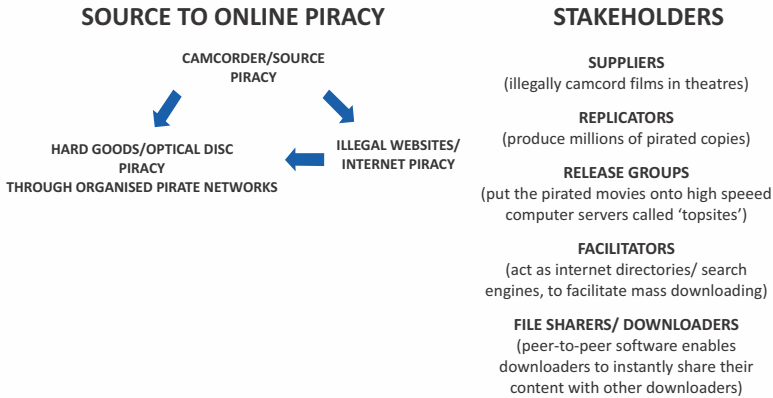

CAMCORDER/ SOURCE PIRACY

“When someone enters a theatre with any type of recording device — camcorder, smartphone, voice recorder, etc. — AND intentionally records or photographs any portion of the video or audio track of a movie, that person is engaging in camcorder piracy.”⁴



Camcorder



Audio Recorder



Remote Control



View Finder



Full Set



High End Mobile

⁴ National Association of Theatre Owners and Motion Pictures Association of America, Inc., Fight Film Theft, available at <http://fightfilmtheft.org/camcorder-privacy.html>

ONLINE PIRACY

Facilitated through Rogue Websites - websites primarily designed with the intention of piracy and are habitual offenders. They are illegitimate, but pose as genuine sites to target Indian online users. They may be hosted on Indian ccTLD or a foreign server.

TYPES OF ROGUE WEBSITES:

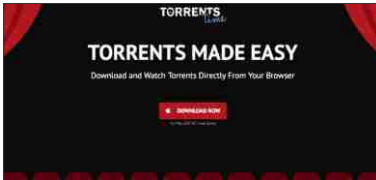

Bit Torrent sites P2P



Video Streaming sites



Cyber Locker



Indexing site

MALWARE & ROGUE WEBSITES

1. Illegal websites lure consumers through illegal copies of popular / newly released films
2. Site supplements income (from advertising and/or subscriptions) by signing up to deliver malware to consumers exposed to the site
3. Consumers accessing content on such a website are at risk of being infected by malware
4. Illegal site earns money for every malware installed on a consumer's computer.

THREAT TO CONSUMERS

1. Can lead to identity theft
2. Insertion of malware on the consumer's system
3. Installation of Remote Access Trojans and risk of Ransomware attack
4. Exposes consumers to high-risk advertising

CYBER CRIME COSTS



No. of illegal Downloads as of 24th Jun'16 : 916,443 downloads

No. of illegal Views as of 24th Jun'16 : 1,630,000 views

Total cumulative illegal downloads/illegal streams : 25,46,443

ORGANISED PIRATE NETWORKS – SOURCE TO ONLINE

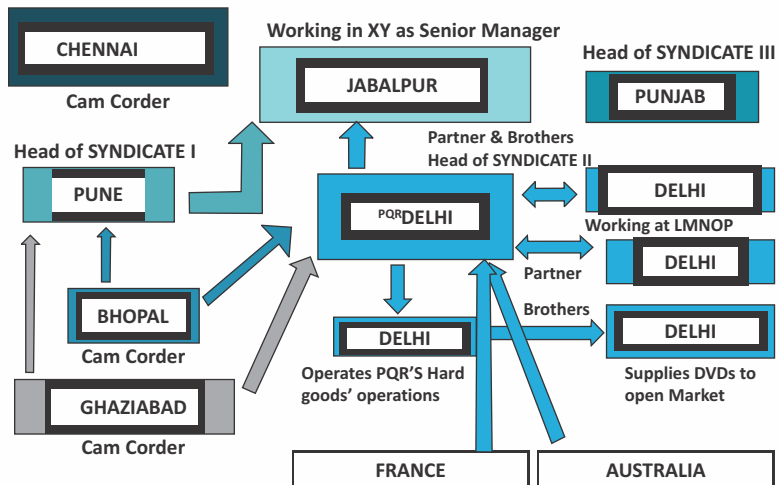



**FEDERATION OF INDIAN CHAMBERS OF
COMMERCE AND INDUSTRY (FICCI)**

Federation House, Tansen Marg, New Delhi-110 001

T: +91-11-2373 8760-70 F: +91-11-2332 0714

W: www.ficci.in



**CELL FOR IPR PROMOTION AND
MANAGEMENT (CIPAM)**

Udyog Bhawan, New Delhi-110011

E: cipam-dipp@gov.in